



Cabinet Locks & Camlocks



“Trusted by the Trade”

www.asec.co.uk



100 1 Lever Straight Cupboard Lock

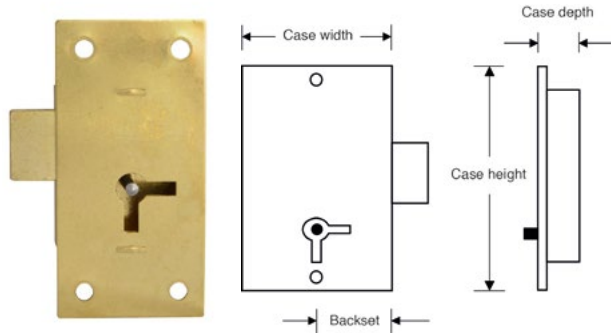

DESCRIPTION

1 Lever straight cupboard lock

- Satin Brass finish
- Screw fixing
- Visi packaging

ASSOCIATED PRODUCTS

Long Pipe Cabinet Blank
7-11 Gauge

PAGE
26

CODE	BACKSET	FINISH	KEYED	KEYS SUPPLIED	WIDTH	CASE HEIGHT	CASE DEPTH
AS6522	11mm	Satin Brass	Keyed Alike	1	38mm	38mm	8mm
AS6523	13mm	Satin Brass	Keyed Alike	1	50mm	50mm	8mm
AS6524	16mm	Satin Brass	Keyed Alike	1	64mm	64mm	10mm
AS6525	19mm	Satin Brass	Keyed Alike	1	75mm	75mm	10mm

15 4 Lever Cut Cupboard Lock

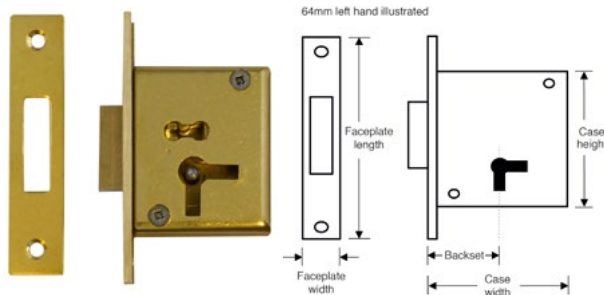

DESCRIPTION

Cut (or mortice in) cupboard lock

- Handed
- 2 Keyed
- 12 differs
- Can be made Keyed alike 50mm special order 63mm via workshop
- Visi packaging

ASSOCIATED PRODUCTS

Long Pipe Cabinet Blank
7-11 Gauge

PAGE
26

CODE	HANDED	BACKSET	FINISH	KEYED	WIDTH	CASE HEIGHT	CASE DEPTH
AS6505	Left Hand	14mm	Satin Brass	Keyed To Differ	50mm	35mm	9mm
AS6506	Left Hand	16mm	Satin Brass	Keyed To Differ	64mm	40mm	11mm
AS6507	Right Hand	14mm	Satin Brass	Keyed To Differ	50mm	35mm	9mm
AS6508	Right Hand	16mm	Satin Brass	Keyed To Differ	64mm	40mm	11mm

150 1 Lever Straight Cupboard Lock

**DESCRIPTION**

57mm or 67mm non handed.

- 2 Keyed
- Black Finish
- Screw fixing
- 1 Lever Mechanism
- Visi packaging

CODE	BACKSET	KEYED	WIDTH	CASE HEIGHT	CASE DEPTH
AS6551	17mm	Keyed Alike	57mm	57mm	10mm
AS6552	20mm	Keyed Alike	64mm	67mm	11mm

155 1 Lever Straight Cupboard Lock

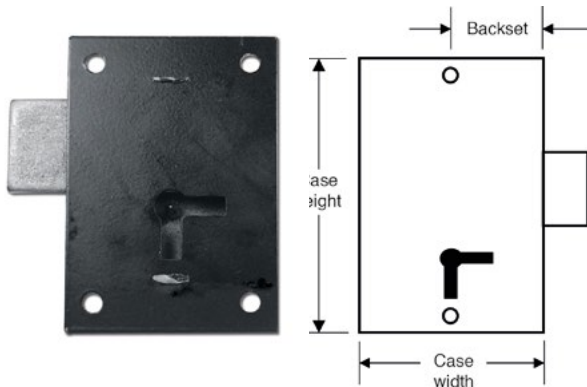
**DESCRIPTION**

75mm ,89mm and 102mm non handed.

- 2 Keyed
- Black Finish
- Screw Fixing
- 1 Lever Mechanism
- Visi packaging

CODE	BACKSET	KEYED	WIDTH	CASE HEIGHT	CASE DEPTH
AS6553	27mm	Keyed Alike	75mm	75mm	12mm
AS6554	27mm	Keyed Alike	89mm	89mm	12mm
AS6555	27mm	Keyed Alike	102mm	100mm	12mm

20 1 Lever Cut Cupboard Lock

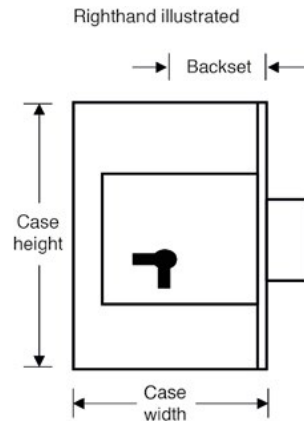

DESCRIPTION

Cut (or mortice in) cupboard lock can be used also for a drawer lock

- Not reversible -handing must be stated when ordering
- Keyed Alike
- 1 Key Supplied
- Visi packaging

ASSOCIATED PRODUCTS

Long Pipe Cabinet Blank
7-11 Gauge

PAGE 26

CODE	HANDED	BACKSET	FINISH	WIDTH	CASE HEIGHT	CASE DEPTH
AS6509	Left Hand	16mm	Satin Brass	64mm	64mm	8mm
AS6510	Right Hand	16mm	Satin Brass	64mm	64mm	8mm

36 2 Lever Straight Cupboard Lock

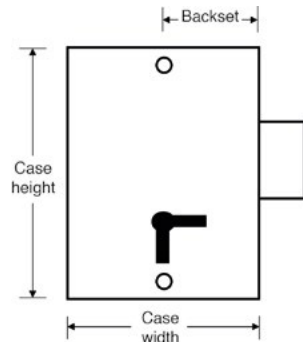

DESCRIPTION

2 Lever straight cupboard lock

- Deadbolt locked and unlocked by key
- face fixing
- 6 Differs
- Satin Brass Finish
- 2 Keys
- 2 Lever
- Visi packaging

ASSOCIATED PRODUCTS

Long Pipe Cabinet Blank
7-11 Gauge

PAGE 26

CODE	BACKSET	KEYED	WIDTH	CASE WIDTH	CASE HEIGHT	CASE DEPTH
AS6526	15mm	Keyed Alike	50mm	29mm	50mm	9mm
AS6527	18mm	Keyed Alike	64mm	37mm	64mm	10mm
AS6528	18mm	Keyed Alike	75mm	37mm	75mm	10mm
AS6529	15mm	Keyed To Differ	50mm	29mm	50mm	9mm
AS6530	18mm	Keyed To Differ	64mm	37mm	64mm	10mm
AS6531	18mm	Keyed To Differ	75mm	37mm	75mm	10mm

48 4 Lever Boxlock

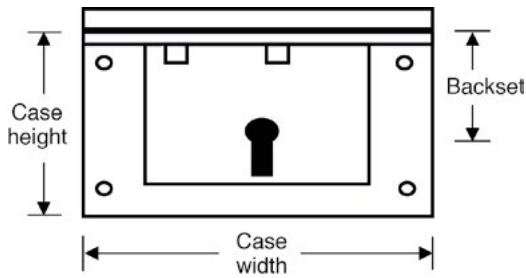
**DESCRIPTION**

A 4 lever box lock were the keep locks in the body of the lock.

- 4 lever locking
- Screw fixed
- Brass keep included
- 12 Differ
- Satin Brass Finish
- 2 Keys Supplied
- Keyed to Differ
- Visi packaging

ASSOCIATED PRODUCTS

Long Pipe Cabinet Blank
7-11 Gauge

PAGE
26

CODE	BACKSET	WIDTH	CASE WIDTH	CASE HEIGHT	CASE DEPTH
AS6503	22mm	64mm	64mm	38mm	10mm
AS6504	26mm	75mm	75mm	42mm	10mm

51 2 & 4 Lever Straight Cupboard Lock

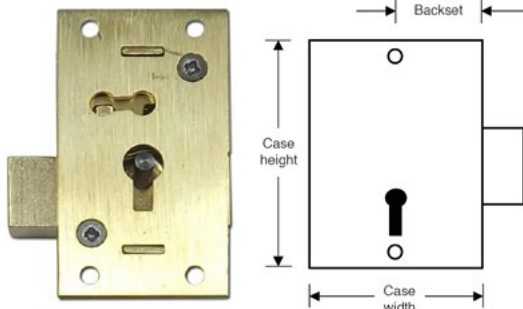
**DESCRIPTION**

Single entry non handed straight cupboard lock.

- Screw fixed
- Satin Brass Finish
- 12 Differ - Supplied with 2 keys
- Visi packaging

ASSOCIATED PRODUCTS

Long Pipe Cabinet Blank
7-11 Gauge

PAGE
26

CODE	KEYED	BACKSET	MECHANISM	WIDTH	CASE WIDTH	CASE HEIGHT	CASE DEPTH
AS6532	Keyed Alike	13mm	4 Lever	50mm	28mm	50mm	10mm
AS6533	Keyed Alike	18mm	4 Lever	64mm	35mm	64mm	11mm
AS6534	Keyed Alike	18mm	4 Lever	75mm	40mm	75mm	11mm
AS6535	Keyed to Differ	13mm	2 Lever	50mm	28mm	50mm	10mm
AS6536	Keyed to Differ	13mm	4 Lever	50mm	28mm	50mm	10mm
AS6537	Keyed to Differ	18mm	2 Lever	64mm	35mm	64mm	11mm
AS6538	Keyed to Differ	18mm	4 Lever	64mm	35mm	64mm	11mm
AS6539	Keyed to Differ	18mm	2 Lever	75mm	40mm	75mm	11mm
AS6540	Keyed to Differ	18mm	4 Lever	75mm	40mm	75mm	11mm

61 4 Lever Cut Cupboard Lock

**DESCRIPTION**

A cut cupboard lock which can be morticed into a frame or drawer, complete with 2 way keyway.

- Satin Brass Finish
- Keyed to Differ
- 4 Lever
- 12 Differs
- 2 Keys Supplied
- Visi packaging

ASSOCIATED PRODUCTS

Long Pipe Cabinet Blank
7-11 Gauge

PAGE
26

CODE	HANDED	BACKSET	WIDTH	CASE WIDTH	CASE HEIGHT	CASE DEPTH
AS6512	Left Hand	16mm	64mm	64mm	64mm	11mm
AS6513	Left Hand	19mm	75mm	75mm	75mm	11mm
AS6515	Right Hand	16mm	64mm	64mm	64mm	11mm
AS6516	Right Hand	19mm	75mm	75mm	75mm	11mm

80 4 Lever Cut Cupboard Lock

**DESCRIPTION**

Sliding cupboard door or desk lock

- Supplied c/w strike plate
- Not reversible - handing must be stated when ordering
- 21mm Backset
- 12 Differs
- Satin Brass Finish
- 13mm Forend Width
- Keyed to Differ
- 2 Keys Supplied
- Visi packaging

ASSOCIATED PRODUCTS

Long Pipe Cabinet Blank
7-11 Gauge

PAGE
26

CODE	HANDED	BACKSET	CASE WIDTH	CASE HEIGHT	CASE DEPTH	MECHANISM	WIDTH
AS6517	Left Hand	21mm	38mm	64mm	10mm	4 Lever	64mm
AS6518	Right Hand	21mm	38mm	64mm	10mm	4 Lever	64mm

85 4 Lever Mortice Cupboard Hooklock

**DESCRIPTION**

Sliding cupboard door or desk lock

- Supplied c/w strike plate
- Not reversible - handing must be stated when ordering
- 12 Differs
- Satin Brass Finish
- Keyed to Differ
- 2 Keys Supplied
- 4 Lever Mechanism
- Visi packaging

ASSOCIATED PRODUCTS

Long Pipe Cabinet Blank
7-11 Gauge

PAGE
26

CODE	HANDED	BACKSET	FOREND WIDTH	FOREND LENGTH	WIDTH	CASE WIDTH	CASE DEPTH
AS6520	Left Hand	17mm	15mm	64mm	64mm	36mm	11mm
AS6521	Right Hand	17mm	15mm	64mm	64mm	36mm	11mm

1 Lever Till Lock

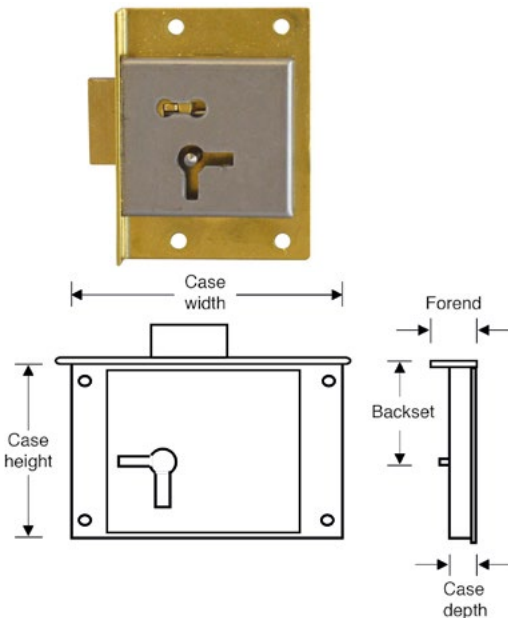
**DESCRIPTION**

50mm 1 lever cut till lock

- Screw fixed
- Satin Brass finish
- Supplied with one key
- 1 Lever Mechanism
- 1 Key Supplied
- Visi packaging

ASSOCIATED PRODUCTS

Long Pipe Cabinet Blank
7-11 Gauge

PAGE
26

CODE	BACKSET	KEYED	WIDTH	CASE WIDTH	CASE HEIGHT	CASE DEPTH
AS6541	16mm	Keyed Alike	50mm	50mm	38mm	8mm
AS6542	19mm	Keyed Alike	64mm	64mm	38mm	8mm

185 4 Lever Desklock

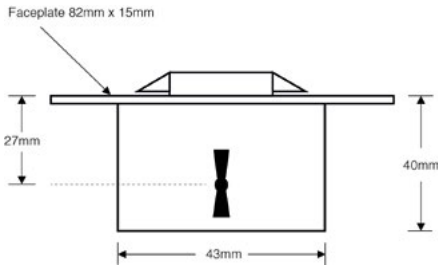
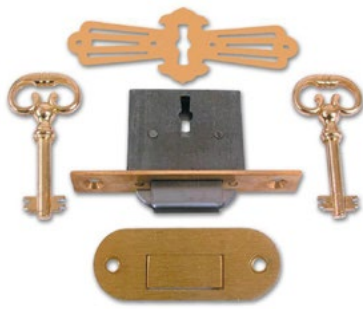

DESCRIPTION

Roll top mortice desk lock.

- Supplied c/w strike plate and decorative escutcheon
- Automatically engages into strike on closing.
- 6 Differs
- Satin Brass Finish
- 2 Keys
- Keyed to Differ
- 4 Lever Mechanism
- Visi packaging

CODE	BACKSET	FOREND WIDTH	FOREND LENGTH	WIDTH	CASE WIDTH	CASE HEIGHT	CASE DEPTH
AS6519	27mm	15mm	82mm	82mm	43mm	40mm	8mm

2 Lever Till Lock

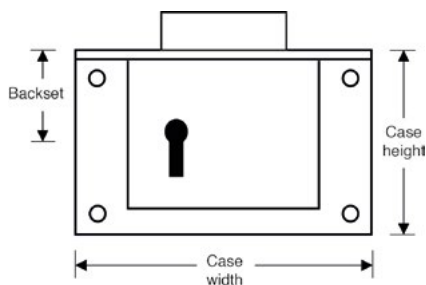

DESCRIPTION

CUT (or mortice in) Till lock for use in drawers

- Deadbolt locked and unlocked by key
- 2 Lever Mechanism
- 2 Keys Supplied
- 12 Differs
- Satin Brass Finish
- Visi packaging

ASSOCIATED PRODUCTS

Long Pipe Cabinet Blank 7-11 Gauge

PAGE 26

CODE	BACKSET	KEYED	WIDTH	CASE HEIGHT	CASE DEPTH
AS6543	16mm	Keyed To Differ	50mm	38mm	9mm
AS6545	21mm	Keyed To Differ	64mm	44mm	10mm

20 Boxlock

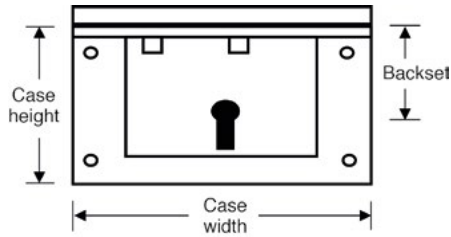
**DESCRIPTION**

Cut (or mortice in) box lock

- Deadbolt locked and unlocked by key
- Keyed to Differ
- Satin Brass Finish
- 1 Key Supplied
- Visi packaging

ASSOCIATED PRODUCTS

Long Pipe Cabinet Blank
7-11 Gauge

PAGE
26

CODE	BACKSET	WIDTH	CASE WIDTH	CASE HEIGHT	CASE DEPTH
AS6500	19mm	50mm	50mm	30mm	9mm
AS6501	21mm	64mm	64mm	35mm	9mm

41 4 Lever Till Lock

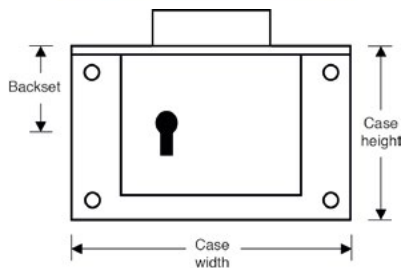
**DESCRIPTION**

4 lever till lock , one way key entry

- 4 lever locking
- Available keyed alike and keyed to differ
- Screw fixed
- Satin Brass Finish
- 2 Keys
- 4 Lever
- 12 Differs
- Visi packaging

ASSOCIATED PRODUCTS

Long Pipe Cabinet Blank
7-11 Gauge

PAGE
26

CODE	BACKSET	KEYED	WIDTH	CASE WIDTH	CASE HEIGHT	CASE DEPTH
AS6544	16mm	Keyed To Differ	50mm	50mm	38mm	9mm
AS6546	21mm	Keyed To Differ	64mm	64mm	44mm	10mm
AS6547	21mm	Keyed To Differ	75mm	75mm	44mm	10mm
AS6548	16mm	Keyed Alike	50mm	50mm	38mm	9mm
AS6549	21mm	Keyed Alike	64mm	64mm	44mm	10mm

Deadbolt Furniture Lock Square Plate



DESCRIPTION

16mm diameter nozzle square backplate deadbolt furniture lock

- 16mm diameter x 19mm nozzle
- 2 Keys Supplied

CODE	DIAMETER	FINISH
AS9952	16mm	Chrome Plated

Deadbolt Furniture Lock Half Moon Plate



DESCRIPTION

22mm diameter nozzle half moon backplate deadbolt furniture lock

- 22mm diameter x 22mm nozzle
- 2 Keys Supplied

CODE	FINISH	KEYED	DIAMETER	NOZZLE DIAMETER	PROJECTION
AS10119	Chrome Plated	Keyed Alike	22mm	22mm	22mm
AS9953	Chrome Plated	Keyed To Differ	22mm	22mm	22mm



Round Rim Cupboard Lock



DESCRIPTION

18mm diameter nozzle round backplate deadbolt furniture lock

- 18mm diameter x 22mm nozzle

CODE	FINISH	KEYS SUPPLIED
AS9957	Chrome Plated	2

Roller Arm Multi Drawer Lock



DESCRIPTION

A 20mm square faceplate roller arm mutli draw lock

- 20mm square faceplate
- Spring clip for metal cabinet applications
- Keyed to differ

CODE	FINISH	FIXING	KEYS SUPPLIED
AS9950	Chrome Plated	Snap	2

Spring Bolt Cylinder Till Lock

**DESCRIPTION**

16mm diameter nozzle square backplate latchbolt furniture lock, with a 10 pin radial key for extra security.

- Available keyed to differ and keyed alike.



CODE	FINISH	KEYED	KEYS SUPPLIED
AS10118	Satin Chrome	Keyed Alike	1
AS9951	Satin Chrome	Keyed To Differ	1

Cabinet Slam Latch

**DESCRIPTION**

Asec 19mm slam action rim lock.

- Supplied complete with 2 keys
- Slam latch
- Nozzle & Flanged
- 2 Keys Supplied
- Visi packaging



CODE	KEYED	FINISH	HEAD SHAPE	LENGTH	BODY LENGTH	HEAD DIAMETER
AS10700	Keyed To Differ	Polished Chrome	Round	10.6mm	19mm	16.3mm

3 Digit Combination Nutfix Camlock

**DESCRIPTION**

A special combination camlock by Asec which can be unlocked by entering its 3 digit code.

- 3 Digit combination
- Camlock
- Nut fix
- 35mm Cam

CODE	FINISH	COMBINATION	FIXING	MOVEMENT	CAM HEIGHT	BODY DEPTH
AS10466	Black	3 Digit	Nut	90° Clockwise	35mm	20mm
AS10467	Silver	3 Digit	Nut	90° Clockwise	35mm	20mm

20mm Latchlock Straight Cam To Accept Padlock

**DESCRIPTION**

A range of nut fixed cam locks designed to accept padlocks to lock them off. Ideal for Schools Colleges and Sports Facilities

- AS9946 is designed to accept 7mm or under diameter shackle padlock
- AS9947 is designed to accept 9mm or under diameter shackle padlock

CODE	FINISH	DIAMETER	SHACKLE DIAMETER
AS9946	Chrome Plated	20mm	7mm
AS9947	Chrome Plated	20mm	9mm

Cranked Cam Latchlock To Suit 9mm Padlock

**DESCRIPTION**

This is a Cam lock which can be used in conjunction with a open shackle padlock.

- 9mm clearance for open shackle padlock
- Cranked cam bar
- 50mm cam bar



CODE	FINISH	HANDLE LENGTH	DIAMETER	SHACKLE DIAMETER
AS9948	Chrome Plated	46mm	18.5mm	9mm

KA Nut Fix Camlock 180°

**DESCRIPTION**

Nut fixed cam lock for metal or timber applications keyed alike .

- Sizes measured from the rose to cam
- Supplied complete with 2 keys
- 35mm straight cam bar
- 180° clockwise movement
- Chrome Plated Finish
- Nut Fixing
- Conical Head Shape
- Visi packaging



CODE	KEYED	BODY WIDTH	BODY HEIGHT	BODY LENGTH	CAM HEIGHT
AS6601	Keyed Alike - "92003"	16mm	19mm	16mm	42mm
AS6616	Keyed Alike - "95010"	16mm	19mm	20mm	42mm
AS6603	Keyed Alike - "92236"	16mm	19mm	20mm	42mm
AS6607	Keyed Alike - "92204"	16mm	19mm	22mm	42mm
AS6609	Keyed Alike - "92205"	16mm	19mm	27mm	42mm
AS6611	Keyed Alike - "92202"	16mm	19mm	32mm	42mm

KD Nut Fix Camlock 180°

**DESCRIPTION**

Nut fixed cam lock for metal or timber applications to differ.

- Sizes measured from the rose to cam
- Supplied complete with 2 keys
- 35mm straight cam bar
- 180° clockwise movement
- Chrome Plated Finish
- Nut Fixing
- Keyed to Differ
- Visi packaging

CODE	HEAD SHAPE	KEY SERIES	CAM HEIGHT	BODY WIDTH	BODY HEIGHT	BODY LENGTH
AS6600	Conical	AS332	42mm	16mm	19mm	16mm
AS6602	Conical	AS336	42mm	16mm	19mm	20mm
AS6614	Conical	AS436	42mm	16mm	19mm	20mm
AS6606	Conical	AS340	42mm	16mm	19mm	22mm
AS6608	Conical	AS341	42mm	16mm	19mm	27mm
AS6610	Conical	AS342	42mm	16mm	19mm	32mm

MK Nut Fix Camlock 180°

**DESCRIPTION**

20mm nut fix cam lock keyed to differ under master key

- Sizes measured from the rose to cam
- 2 keys
- Master key AS6618
- 180° clockwise movement
- Chrome Plated Finish
- Nut Fixing
- Visi packaging

ASSOCIATED PRODUCTS

AS436/439-53 Master Key
AS6618 - AS436/439-53

PAGE
26

CODE	FINISH	HEAD SHAPE	CAM HEIGHT	BODY WIDTH	BODY HEIGHT	BODY LENGTH
AS6613	Chrome Plated	Conical	35mm	16mm	19mm	20mm

Round KA Nut Fix Camlock 90°

**DESCRIPTION**

Easy to install round faced nut fix camlocks, designed to fit metal and timber cupboards and cabinets. These cam locks are keyed alike, and feature 90° turn.

- 90° clockwise movement
- Supplied with 2 keys
- Sizes measured from the rose to cam
- Chrome Plated Record
- Nut Fixing
- Visi packaging

CODE	KEY SERIES	KEYED	CAM HEIGHT	BODY WIDTH	BODY HEIGHT	BODY LENGTH
AS11457	92	Keyed Alike	42mm	16mm	19mm	11mm
AS660190	92	Keyed Alike	42mm	16mm	19mm	16mm
AS661690	92	Keyed Alike	42mm	16mm	20mm	16mm
AS660390	92	Keyed Alike	42mm	16mm	19mm	20mm
AS660790	92	Keyed Alike	42mm	16mm	19mm	22mm
AS660990	92	Keyed Alike	42mm	16mm	19mm	27mm
AS661190	92	Keyed Alike	42mm	16mm	19mm	32mm

Round KD Nut Fix Camlock 90°

**DESCRIPTION**

Easy to install round faced nut fix camlocks, designed to fit metal and timber cupboards and cabinets. These cam locks are keyed to differ, and feature 90° turn.

- 90° clockwise movement
- Supplied with 2 keys
- Sizes measured from the rose to cam
- Chrome Plated Finish
- Nut Fixing
- Keyed to Differ
- Visi packaging

CODE	KEY SERIES	CAM HEIGHT	BODY WIDTH	BODY HEIGHT	BODY LENGTH
AS660090	92	42mm	16mm	19mm	16mm
AS660290	92	42mm	16mm	19mm	20mm
AS661490	95	42mm	16mm	19mm	20mm
AS660690	92	42mm	16mm	19mm	22mm
AS660890	92	42mm	16mm	19mm	27mm
AS661090	92	42mm	16mm	19mm	32mm

Round Mini KD Nut Fix Camlock 180°

**DESCRIPTION**

Asec round faced nut fixed cam lock suitable for metal or timber applications, also available in a square faced format.

- Round faced version
- Sizes measured from the rose to cam
- Supplied complete with 2 keys
- Keyed to differ
- Chrome Plated Finish
- Nut Fixing
- Round Head Shape
- 180° clockwise movement
- Visi packaging

CODE	KEY SERIES	CAM HEIGHT	BODY LENGTH	BODY DIAMETER
ASI0696	801	41.5mm	8mm	22mm

Square Mini KD Nut Fix Camlock 180°

**DESCRIPTION**

Asec square faced nut fixed cam lock suitable for metal or timber applications, also available in a round faced format.

- Square faced version
- Sizes measured from the rose to cam
- Supplied complete with 2 keys
- Keyed to differ
- Chrome Plated Finish
- Nut Fixing
- 180° clockwise movement
- Square Head Shape
- Visi packaging

CODE	KEY SERIES	CAM HEIGHT	BODY LENGTH	BODY DIAMETER
ASI0697	801	41.5mm	8mm	20mm

Camlock To Suit DAD Post Box



DESCRIPTION

A 15mm cranked cam camlock to suit various post boxes

- Horseshoe fixing
- 2 keys
- Visi packaging

CODE	FINISH	KEYED
AS6619	Chrome Plated	Keyed To Differ

Lion Style Snap Fix Cranked Cam Camlock



DESCRIPTION

A cranked cam snap fix camlock designed as a replacement Lion style lock

- To differ under the 95-97 series master key.
- The cylinder is key retaining
- Keyed to differ
- Supplied complete with 2 keys

CODE	FINISH	FIXING	KEY SERIES	BODY LENGTH
ASI0096	Chrome Plated	Snap	95-97	20mm

Round KA Snap Fit Camlock 180°

**DESCRIPTION**

Easy to install round face snap fit cam locks designed to fit metal cupboards and cabinets. These cam locks are supplied complete with 2 keys and spring steel locking plate.

- 180° clockwise movement
- Supplied with 2 keys
- Sizes measured from the rose to cam
- Chrome Plated Finish
- Round Head Shape
- Keyed Alike
- Snap Fixing
- Visi packaging

CODE	CAM HEIGHT	BODY WIDTH	BODY HEIGHT	BODY LENGTH
AS6605	42mm	17mm	17mm	20mm

Round KD Snap Fit Camlock 180°

**DESCRIPTION**

Easy to install round faced snap fit cam locks designed to fit metal cupboards and cabinets. These cam locks are supplied complete with 2 keys and spring steel locking plate.

- 180° clockwise movement
- Supplied with 2 keys
- Sizes measured from the rose to cam
- Chrome Plated Finish
- Snap Fixing
- Round Head Shape
- Keyed to Differ
- Visi packaging

CODE	CAM HEIGHT	BODY WIDTH	BODY HEIGHT	BODY LENGTH
AS6604	42mm	17mm	17mm	20mm

Snap Fit Cranked Cam Camlock To Suit Garron Lockers



DESCRIPTION

A snap fit camlock designed to suit Garron lockers.

- To Suit Garron Lockers
- Cranked Cam
- 90° CW Operation
- Supplied With 2 Keys
- Snap Fit Horseshoe Clip
- Keyed to Differ
- Chrome Plated Finish
- Key Retaining
- Snap Fixing



CODE	CAM HEIGHT	BODY HEIGHT	BODY LENGTH
ASI0327	58mm	21.5mm	20mm

Snap Fit Cranked Cam Camlock To Suit Link Lockers



DESCRIPTION

A snap fit camlock designed to suit Link lockers.

- To Suit Link Lockers
- Cranked Cam
- 90° CW Operation
- Supplied With 2 Keys
- Snap Fit Horseshoe Clip
- Keyed to Differ
- Snap Fixing
- Chrome Plated Finish



CODE	CAM HEIGHT	BODY HEIGHT	BODY LENGTH
ASI0326	56mm	19mm	22.5mm

Square KD Snap Fit Camlock 180°

**DESCRIPTION**

Easy to install square faced snap fit cam locks designed to fit metal cupboards and cabinets. These cam locks are supplied complete with 2 keys and spring steel locking plate.

- 180° clockwise movement
- Supplied with 2 keys
- Sizes measured from the rose to cam
- Chrome Plated Finish
- Snap Fixing
- Keyed to Differ
- Square Head Shape
- Visi packaging

CODE	CAM HEIGHT	BODY WIDTH	BODY HEIGHT	BODY LENGTH
AS6615	42mm	17mm	17mm	20mm

Square MK Snap Fit Camlock 180°

**DESCRIPTION**

Easy to install square faced snap fit cam locks designed to fit metal cupboards and cabinets. These cam locks are supplied complete with 2 keys and spring steel locking plate.

- 180° clockwise movement
- Supplied with 2 keys
- Sizes measured from the rose to cam
- Chrome Plated Finish
- Snap Fixing
- Square Head Shape
- Visi packaging

ASSOCIATED PRODUCTS

AS436/439-53 Master Key
 AS6618 - AS436/439-53

PAGE
26

CODE	CAM HEIGHT	BODY WIDTH	BODY HEIGHT	BODY LENGTH
AS6617	42mm	17mm	17mm	20mm

Single Flange Fix Furniture Pedestal Lock

**DESCRIPTION**

Drawer / cabinet lock with a single fixing for narrow applications

- 2 Keyed
- 180 Degree lock/unlocked



CODE	FINISH	KEYS SUPPLIED
AS9958	Chrome Plated	2

Half Cut Out Cam Furniture Pedestal Lock

**DESCRIPTION**

Drawer / cabinet lock with a single fixing for narrow applications, cam cut away to suit locking bars

- 2 Keyed
- 180 Degree lock/unlocked



CODE	FINISH	KEYS SUPPLIED
AS9955	Chrome Plated	2

MKD Twin Flange Fix Furniture Pedestal Lock

**DESCRIPTION**

Drawer / cabinet lock with a twin fixing back plate

- 2 Keyed
- 180 Degree lock/unlocked

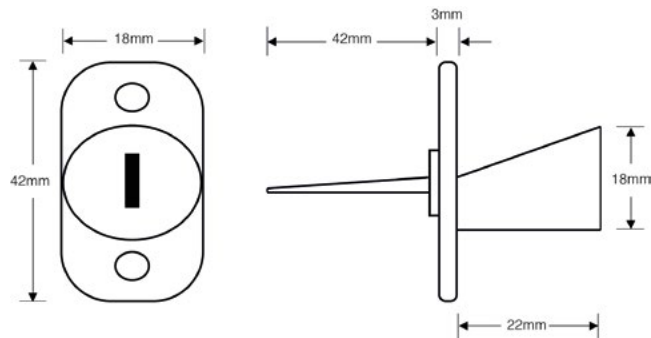
**CODE**

AS9956

FINISH

Chrome Plated

KEYS SUPPLIED

2

Twin Flange Fix Furniture Pedestal Hook Cam Lock

**DESCRIPTION**

Drawer / cabinet lock with a twin fixing back plate, and hook

- 2 Keyed
- 180 Degree lock/unlocked

**CODE**

AS9959

FINISH

Chrome Plated

KEYS SUPPLIED

2

Peg Snap Fix Furniture Pedestal Lock



DESCRIPTION

Push fit cylindrical drawer / cabinet lock radius face

- 2 Keyed
- 180 Degree lock/unlocked



CODE	FINISH	KEYS SUPPLIED
AS9954	Black	2

Furniture Pedestal Lock



DESCRIPTION

Push fit cylindrical drawer / cabinet lock square face

- 2 Keyed
- 180 Degree lock/unlocked



CODE	FINISH	KEYS SUPPLIED	FACEPLATE WIDTH	FACEPLATE HEIGHT	LENGTH
AS9949	Chrome Plated	2	17mm	23mm	51mm

Furniture Lock Camlock

**DESCRIPTION**

Screw fixed pedestal lock with single screw fix.

- Suitable for wooden furniture
- 40mm actuator arm
- 180° Anti Clockwise Movement
- Visi packaging

CODE	FINISH	DIFFERS	KEYS SUPPLIED	CYLINDER DIAMETER
AS6620	Bright Chrome	200	2	19mm (Body) x 16mm (Barrel)

Screw Fix Furniture Lock

**DESCRIPTION**

Asec double flange furniture lock available with a horizontal or vertical fixing.

- Supplied complete with 2 keys
- Vertical or horizontal fixing
- Furniture lock
- 180° Key movement
- Keyed to differ
- Visi packaging

CODE	FIXING	HEAD SHAPE	BODY LENGTH	HEAD DIAMETER
ASI0698	Vertical	Round	19mm	16.5mm
ASI0699	Horizontal	Round	19mm	16.5mm

Furniture Lock Strike Plate



DESCRIPTION

The Asec Furniture Lock Strike Plate is suitable for use with both Asec and Lowe & Fletcher Furniture Locks.

- To suit Asec & L&F Furniture Locks
- 2 screw holes
- Solid metal construction

CODE	FINISH	SUITS MANUFACTURER	WIDTH	HEIGHT	LENGTH
AS10463	Silver	Asec & Lowe & Fletcher	11.3mm	11.7mm	40.4mm

Cabinet & Camlock Wall Board



DESCRIPTION

Display Board for Asec Cam locks but can be utilised for other Asec products.

- Display board only
- Complete with hooks

CODE

L12495

UNIVERSAL - Long Pipe Cabinet Blank



Image to scale

DESCRIPTION

Multi purpose key blank to suit various cabinet locks

- Asec Key Blank

CODE	SIZE
AS11084	7 Gauge
AS11085	8 Gauge
AS11086	9 Gauge
AS11082	10 Gauge
AS11083	11 Gauge

AS436/439-53 Master Key

**DESCRIPTION**

Master key to suit AS6613 & AS6617 Cam locks

- Genuine Asec Master Key

CODE	SUITS MANUFACTURER
AS6618	Asec

A series of horizontal dotted lines for writing notes.

A series of horizontal dotted lines for writing notes.

“Trusted by the Trade”

www.asec.co.uk

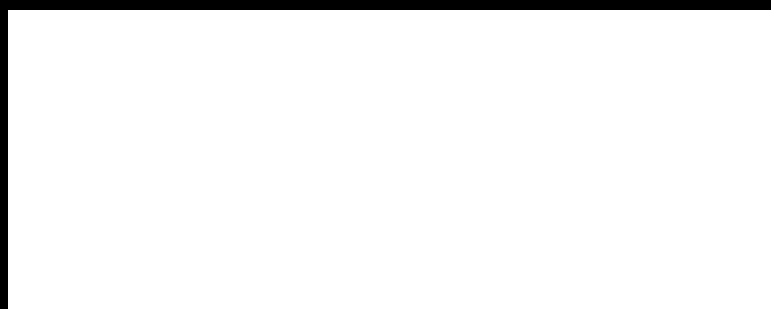



This is Asec.

www.asec.co.uk